

# TRUE BLUE POWER®



A division of Mid-Continent Instrument Co., Inc.

## Advanced Lithium-ion Battery

### TB14

Manufactured by Mid-Continent Instrument Co., Inc.



TB14

**Delivers more power per pound  
than any other aircraft battery**

The TB14 is designed for smaller, 28-volt fixed-wing aircraft. It delivers cooler and faster engine starts and ensures superior performance in extreme temperatures (-20°C to +70°C).

The lithium-ion main ship battery offers on-condition maintenance and features built-in charge current limiting to protect your aircraft's alternator or generator without needing to install additional equipment. The TB14 delivers intelligent cockpit communication via RS-232, analog and discrete signals.

### Product features

CAPACITY	13 amp-hour nominal at 23°C/73.4°F
WEIGHT	6430014-2 10.0 lbs. (4.6 kg) 6430014-21 12.2 lbs. (5.5 kg)
TECHNOLOGY	Advanced iron phosphate lithium-ion cell chemistry
EFFICIENCY	Higher voltage during engine start — Less wear, less maintenance and increased useful life
PERFORMANCE	35 minutes (at 28 amps average) for complete recharge when the battery is fully discharged  Superior high-temperature and cold-weather performance from -20°C to +70°C (-4°F to +158°F)
ENERGY DENSITY	More than 1 amp-hour per pound
PROTECTION	Overcharge, over-discharge, over-current, short circuit, over-temperature, under-temperature and charge current limiting
COMMUNICATION	RS-232, Analog, Discrete
MAINTENANCE	On-condition
DESIGNED AND MANUFACTURED	Wichita, Kansas, USA
WARRANTY	Two-year limited

#### Kansas

9400 East 34th Street North  
Wichita, Kansas 67226 USA  
Tel 316.630.0101 800.821.1212  
Fax 316.630.0723  
tbp@mcico.com

#### California

9722 Topanga Canyon Boulevard  
Chatsworth, California 91311 USA  
Tel 818.786.0300 800.345.7599  
Fax 818.786.2734  
tbp@mcico.com

[truebluepowerusa.com](http://truebluepowerusa.com)

# Advanced Lithium-ion Battery

## TB14

Manufactured by Mid-Continent Instrument Co., Inc.

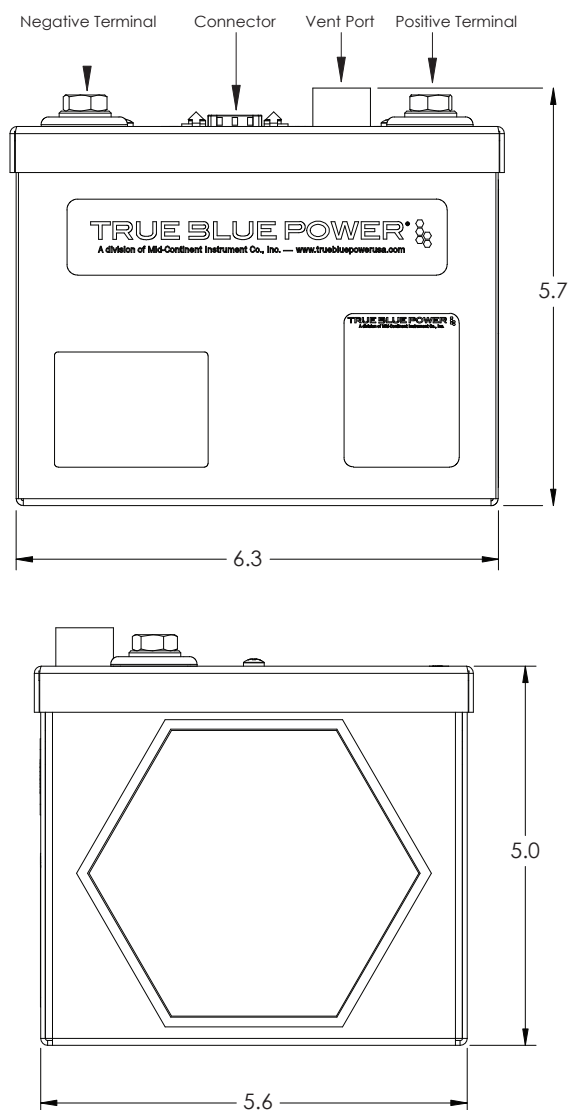

### Technical specifications

CAPACITY	13 amp-hour nominal at 23°C/73.4°F
CHARGE VOLTAGE	28.8 VDC nominal
OUTPUT VOLTAGE	26.4 VDC nominal
OUTPUT CURRENT	100A continuous, 850A max
TECHNOLOGY	Advanced iron phosphate lithium-ion cell chemistry
PROTECTION	Overcharge, over-discharge, over-current, short circuit, over-temperature, under-temperature and charge current limiting
ENERGY DENSITY	76 Wh/kg 121 Wh/liter
OPERATING TEMPERATURE	-20°C to 70°C (-4°F to 158°F)
WEIGHT	6430014-2 10.0 lbs. (4.6 kg) 6430014-21 12.2 lbs. (5.5 kg)
DIMENSIONS	6.3" L x 5.6" W x 5.0" H
CONFIGURATION	2P8S; 2 parallel cells x 8 series cells
LIFE EXPECTANCY	8 years (average)
MAINTENANCE	On-condition
CASE	6430014-2 Anodized aluminum, blue 6430014-21 Stainless steel
CERTIFICATION	FAA TSO C179b (Class A-4B) RTCA DO-311A RTCA DO-160G RTCA DO-178C DAL A UNDOT/IATA

### Product comparison

	Battery Technology	Voltage Output	Capacity (1C rate)	Weight	Maintenance	Useful Life
TB14	Lithium-ion (6430014-2)	26.4 VDC	13 amp-hour	10 lbs.	On-condition	8 years (average)
	Lead-acid	24 VDC	13.6 amp-hour	29.5 lbs.	Annual	2 – 4 years
	Nickel-cadmium	24 VDC	15 amp-hour	36.8 lbs.	200 – 400 hours	5 – 10 years